

N -SERIES



SAVE TODAY'S ENERGY FOR TOMORROW



ISO9001
ISO14001
ISO50001



RoHS
Compliant

IP66
IK10

LM-80

3 YEAR
WARRANTY

LED SOLAR STREET LIGHTS



Overview

The ZGSM® N-Series Solar LED street lights are using ZGSM Latest N Series High efficacy LED Luminaire, providing excellent lumen output, long-lasting stability and splendid sight.

Combined with Lithium battery and Mono Solar Panels to ensure the long life and high efficacy of system. Provide 3 years warranty on whole system.

Color Options

■ Deep Gray

HIGH EFFICACY LED CHIPS



Lumileds 3030 2D
Greater than 195lm/ w high efficacy, illumination grade LED light source.



Lumileds 5050
Greater than 200lm/ w high efficacy, illumination grade LED light source.

SELF-CLEANING DESIGN



Smooth body will greatly diminish dust accumulation and bird dropping build-up.

SMART DESIGN



The first driver-less design greatly reduces the volume of the luminaire and reduces the transportation cost under the conditions of heat dissipation.

WATERPROOF ALUMINUM BOX WITH LITHIUM BATTERY AND CHARGE CONTROLLER

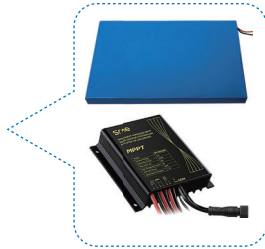

Main Features

- Adopts MPPT charging method, which increases the utilization of solar panel.
- Lithium battery low temperature charging protection, which effectively protects the battery .
- Intelligent computing, detecting the ratio of charge and discharge, to achieve the lights stay on 365 days.
- If no charge within 24 hours, the system automatically goes into hibernation, easy to transport long-distance, long-term storage to avoid causing battery bursts.
- Realize Bluetooth communication between the mobile phone and the system, users can customize the lighting mode and view the system operation in real time.
- Integrated Battery Management System (BMS) which monitors the health, charging and discharging of the battery pack. This safeguards the cells so that they are not over charged or discharged, maximising their lifetime.
- Overheat protection function, when the controller reaches a certain temperature, it will decrease or close the load.
- Working status indication, easy to maintain.

HIGH EFFICACY SOLAR PANEL



High Conversion Efficiency of Module (from 19% to 20%), with superior cell technology and leading manufacturing capability. The solar panels are CE certified and carry a 10-year product warranty. Hail-resistant and corrosion-proof. Rated outputs on the panels are 90% minimum for the first 10 years and 80% minimum after 25 years.

OPTIONAL ACCESSORIES



Bracket for solar panels



Mounting arm for luminaires

The Q235 steel is heated galvanized and sprayed to ensure that the mounting bracket of solar panels and the mounting arm of luminaires can be used in outside for long time.

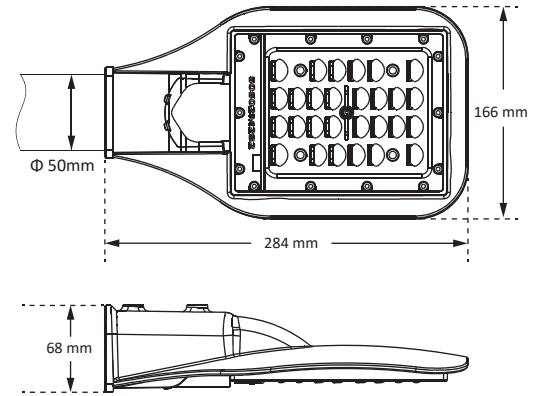

Electrical & Photometric

Model	Power	Luminaire efficacy (+/- 5%)	Lumen Output (+/- 5%)	Solar Panel Spec.	Battery Spec. (Lithium)	Smart Controller	Charge Time	Working Environment	Storage Temperature	Rating	CRI	Material
ZGSM-LD20N	20W	175 /180 lm /w	3500 /3600 lm	60W Monocrystal	212 WH	365Days ON	5 Hours	0 °C ~ 60 °C 10% ~ 90%RH	-40 °C ~ +50 °C	IP66 IK10	>70	Housing: Die-cast aluminum Lens: PC
ZGSM-LD30N	30W	170 /175 lm /w	5100 /5250 lm	80W Monocrystal	298 WH	365Days ON	5 Hours					
ZGSM-LD40N	40W	165 /170 lm /w	6600 /6800 lm	120W Monocrystal	426 WH	365Days ON	5 Hours					
ZGSM-LD50N	50W	160 /165 lm /w	8000 /8250 lm	150W Monocrystal	512 WH	365Days ON	5 Hours					

Working Environment & Packing

Model	Product Dimensions(Lamp /Solar Panel /Battery) (mm)	Carton Size(Lamp /Solar Panel /Battery) (mm)	N.W(Lamp /Solar Panel /Battery) (kg)	G.W(Lamp /Solar Panel /Battery) (kg)
ZGSM-LD20N	284*166*68 /670*620*450*640 /220*113*95	290*180*100 /715*635*110 /355*130*105	1.0 /4.3 /2.65	1.53 /7.0 /2.79
ZGSM-LD30N	284*166*68 /670*790*450*640/220*113*95	290*180*100 /805*715*110 /355*130*105	1.0 /5.6 /3.68	1.53 /8.6 /3.82
ZGSM-LD40N	284*166*68 /670*1095*450*640 /420*113*95	290*180*100 /1110*715*110 /550*130*105	1.0 /7.6 /4.94	1.53 /12.0 /5.14
ZGSM-LD50N	284*166*68 /670*1330*450*640 /500*113*95	290*180*100 /1345*715*110/550*130*105	1.0 /9.1 /5.88	1.53 /15.0 / 6.08

Note: Above data of weight are all typical values.

Optics

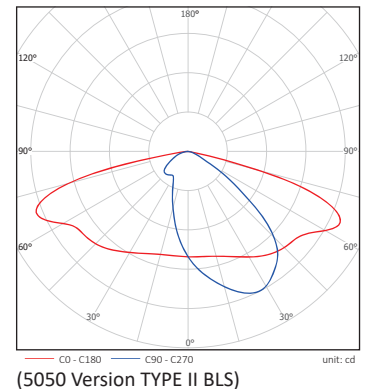
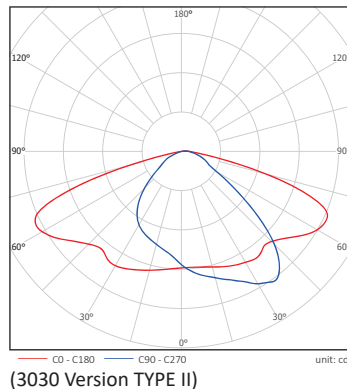
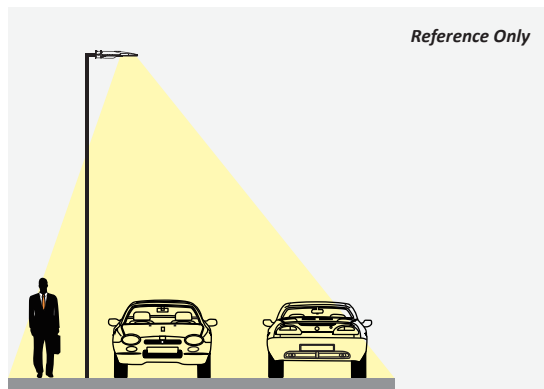

Solar Street Light System

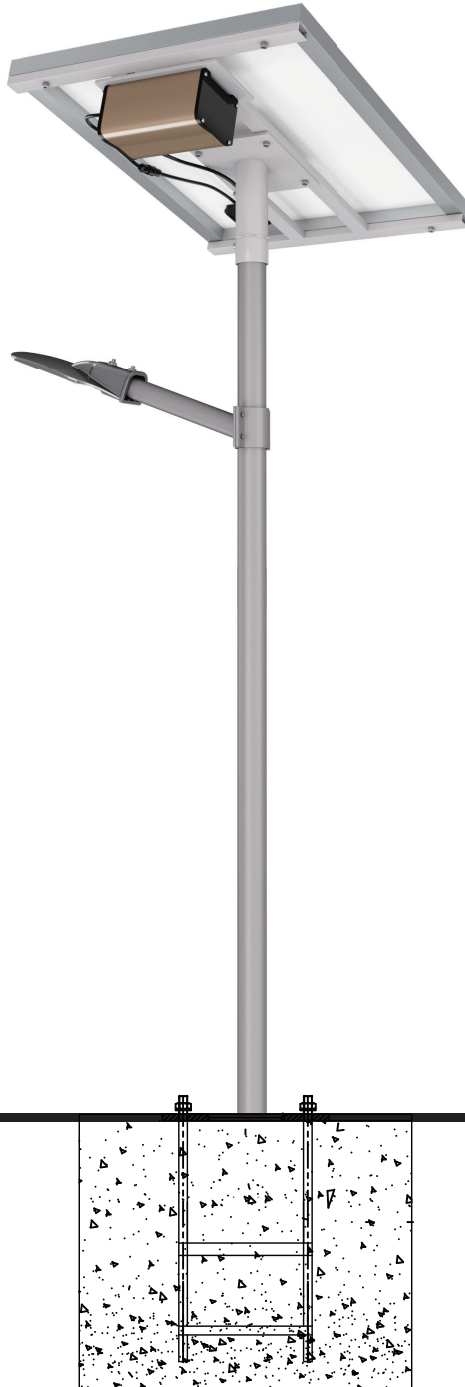

Model list:
ZGSM-LD20N
ZGSM-LD30N
ZGSM-LD40N
ZGSM-LD50N

Solar Panel with bracket



Waterproof Aluminum Box With Lithium Battery and Charge Controller

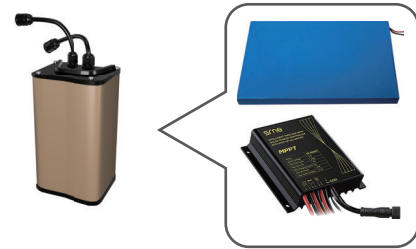

Parts Connection Diagram

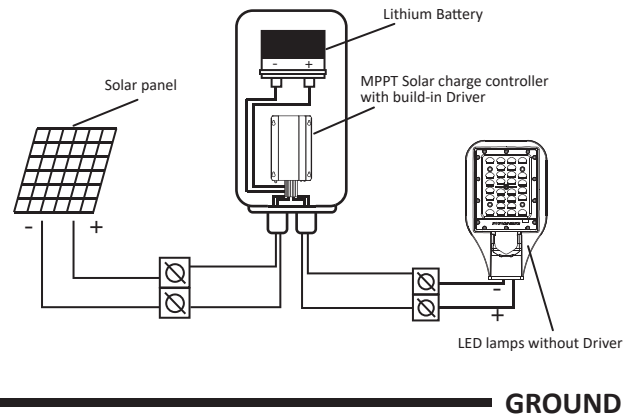

Customized service

Due to each city has its own sunshine condition, and customers have different working hours and rainy days on request.

If you want to know more exact configuration, please contact us for below questions:

1. What is the geographical location your solar LED street lighting system will be installed?
2. How many hours per night the LED street light works?
3. How many days to backup in case of continuous rainy days?
4. Do you need dimming the LED street light (during the off-peak hours)?
5. Do you have any other requirements?