

HALO

LED High Bay Light

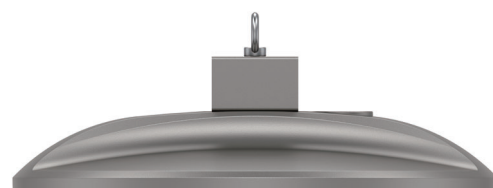
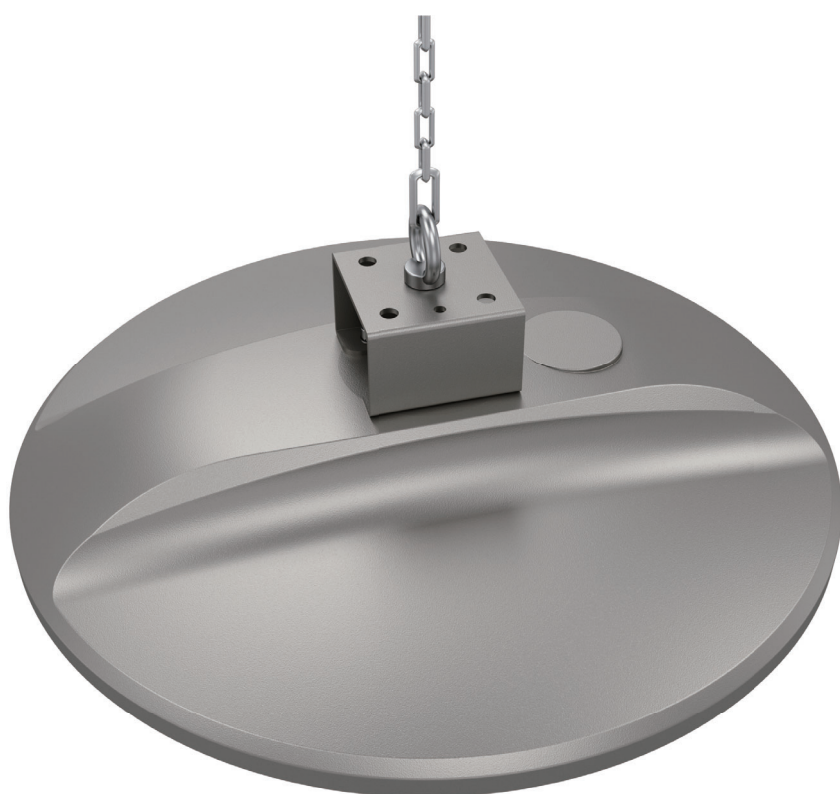

Areas of application

- Warehouse
- Garages
- Workshop
- Commercial Facilities
- Aisles (Open & Stock)
- Field Houses & Gymnasiums

5 YEAR
WARRANTY

Product Benefits

- Light efficiency up to 175lm/w
- Up to 100,000hrs @ L70, low maintenance cost
- World class, approbated quality components (LEDs /Driver /etc.)
- Smooth body would greatly diminish dust accumulation
- Six mounting options, post top, pendant, suspension, side entry and etc
- 5 years warranty



Product Datasheet

Specifications:

Model No	ZGSM-ST20-30HB	ZGSM-ST20-30HB*	ZGSM-ST20-50HB	ZGSM-ST20-50HB*	ZGSM-ST20-80HB
Nominal Wattage	30W	30W	50W	50W	80W
Efficiency	155 lm /w	175 lm /w	160 lm /w	175 lm /w	155 lm /w
Lumen	4650 lm	5250 lm	8000 lm	8750 lm	12400 lm
Model No	ZGSM-ST20-80HB*	ZGSM-ST20-100HB	ZGSM-ST20-100HB*	ZGSM-ST20-120HB	ZGSM-ST20-150HB
Nominal Wattage	80W	100W	100W	120W	150W
Efficiency	165 lm /w	150 lm /w	160 lm /w	150 lm /w	150 lm /w
Lumen	13200 lm	15000 lm	16000 lm	18000 lm	22500 lm

- Above values are calculated based on the product with CCT over 3000K, values of 3000K are 5% lower than above values.
- Luminous efficacy values are different when the same model with different optical lenses.
- Values shown are subject to $\pm 5\%$ tolerance.
- Model No with "*" means high efficiency version.

Electrical Data:

Nominal Voltage	AC 100-240V /277V 50 /60Hz
LED	Lumileds
Driver	Inventronics /Other brands on request
Power Factor (PF)	>0.95
THD	<15
SPD	10KV (Default) /20KV (available on request)
Optics	60°, 90°, 120°
Standard Deviation of Color Matching	<5 SDCM
CRI	Ra>70 (Default) /Ra>80
CCT	3000K, 4000K, 5000K, 5700K

General Data

Body Material	High pressure die-cast aluminum
Housing Color	Gray (RAL9007) /Black (available on request)
Cover Material	Tempered glass
Lens Material	UV-resistant Polycarbonate
Working Environment	-40°C ~ +50°C, 10% ~ 90%RH
Lifespan L70 at 25 °C	>100, 000 h
Mounting Type	Hook Loop
Dimmable	1-10V Dimming (Default) /Timer Dimming
Protection Class	Class I (Default) /Class II
Standards	CE, RoHS, ENEC, CB, LM79, LM80, TM-21, IP66, IK08/IK10
Available on request	Motion sensor, NTC, OLC, DALI Dimming, Zigbee /Lora Control

Product Datasheet

Light Distributions

Order reference

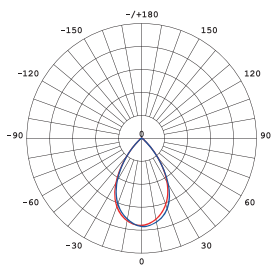
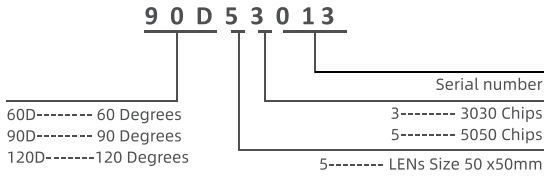

60D53012

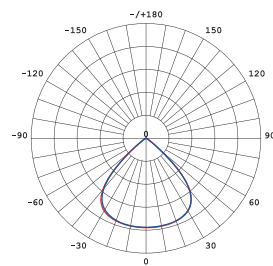

90D53013

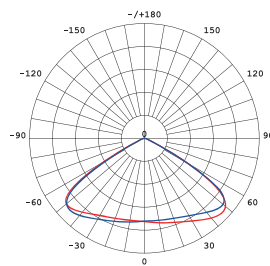

120D53014

Dimension

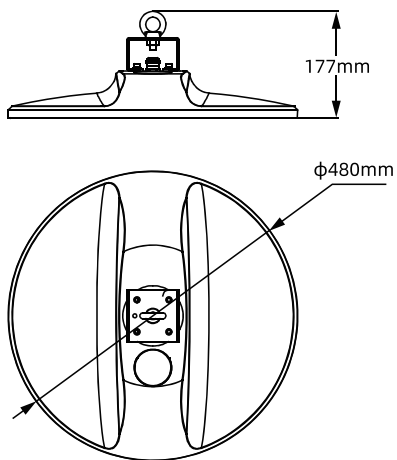

Product Information



Packing Type	Package Dimension (mm)	Fixture Weight (kg)	Package Weight (kg)
1 unit / ctn	495*495*170	6.3	7.3

Smart Control

Microwave Motion Sensor



When used in combination with 0-10V dimmable LED drivers, the sensors can achieve 3-step dimming function, 100%---> low light --->off. And the sensors have built in adjustable daylight sensors, which are very easy to install and cost-effective.

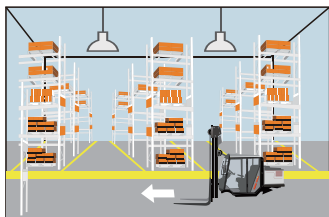

With sufficient ambient light, the sensor does not switch on the lamp.

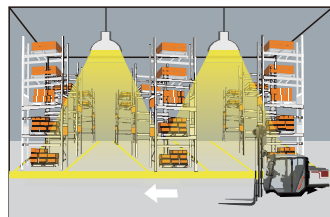

With insufficient ambient light, the sensor switches on the lamp when motion is detected.

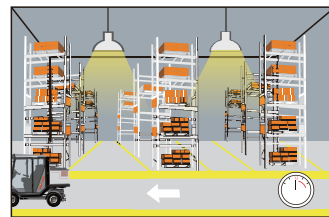

After hold time, the sensor dims the lamp at a low light level if no new motion trigger.

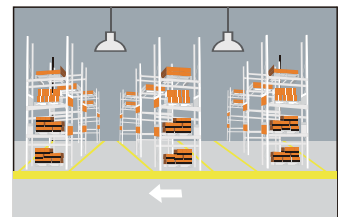

After stand-by period, the sensor switches off the lamp if no motion is detected in its detection zone.

Zigbee Wireless Control System

ZigBee 2.4G 1-10V dimming LED controller Connected to a dimming driver, this controller shows real-time data on App, such as current, power rate and power consumption. It is applied to street, office and industry LED lighting for dimming purposes. It works with 1-10V or 0-10V dimming drivers. Also it works with ZigBee lighting control system to achieve short-distance or long-distance controlling led lights by Mobile Phone, Tablet, PC, Touch Switch, Remote Control, Daylight Sensor and Motion Sensor.

System Diagram

