

# ZG-1097

## Post Top Luminaires

---





## HEAT DISSIPATION PERFORMANCE

Advanced FEA technology designs for the structure thermal transfer to guarantee the LED PCB and chips can use for long life.

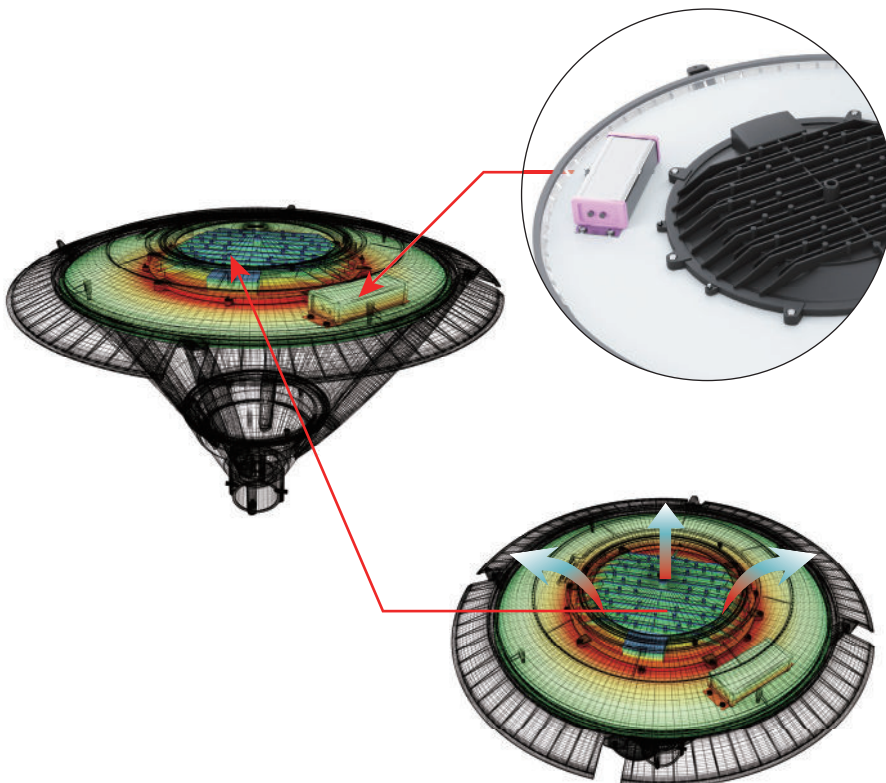

Non-contact structure for LED drivers and heat sinks. The electrical parts are in cool status.

Stretching aluminum heat sinker is designed inside. The air convection structure enhances the lumen maintenance performance.

## **THERMAL- ELECTRICAL DIVIDED**

Product Overview

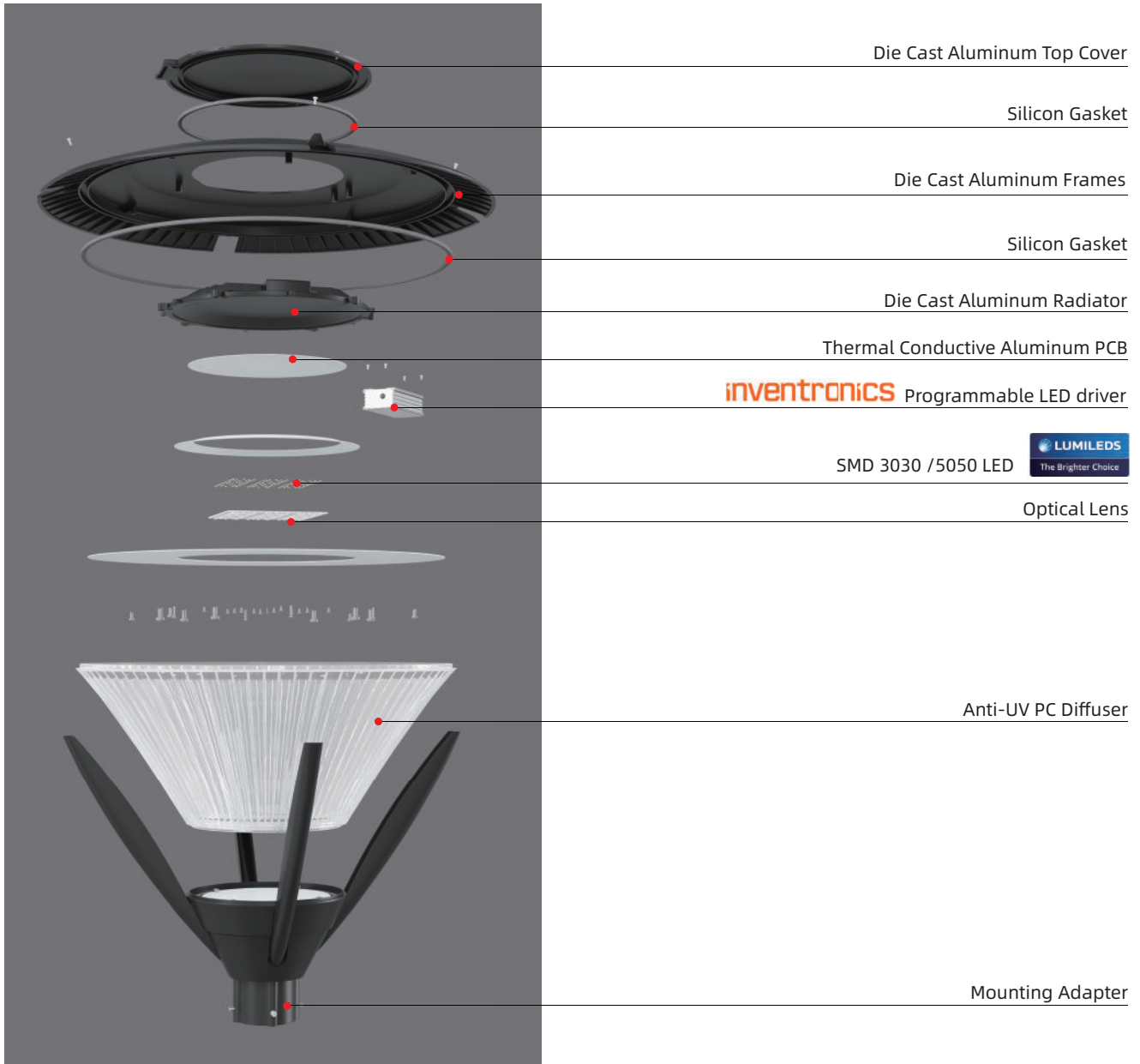

Dimension(mm)

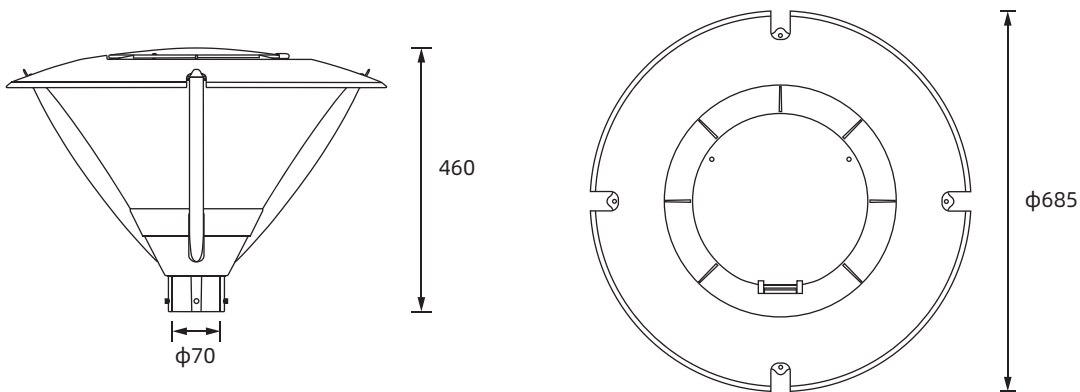

Light Distributions

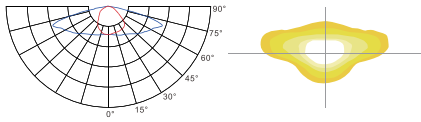

Type I 30x150

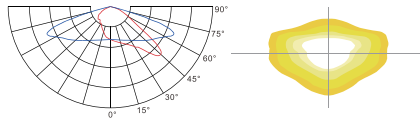

Type II 45x140

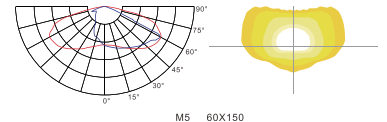

M5 60x150

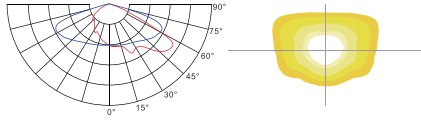

Type III 58x130

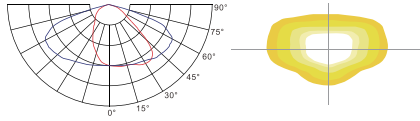

Ver B 35x140

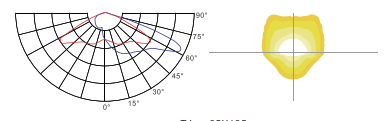

T4 65x135

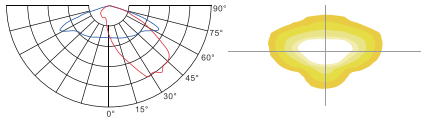

M1 45x130

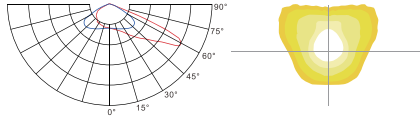

M6 60x135

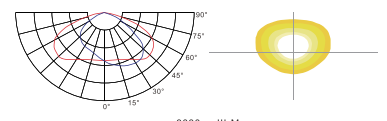

3030 III-M

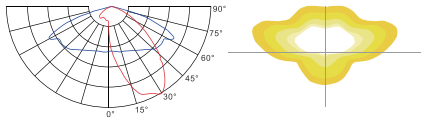

R3 25x140

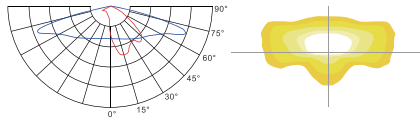

P4 20x145

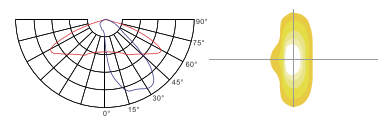

M2 30x130

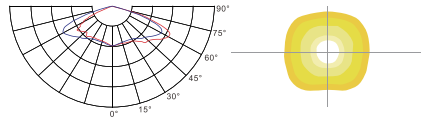

Type V 130x130

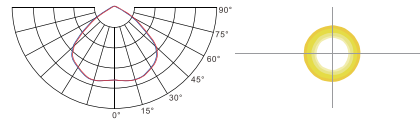

V90 90x90

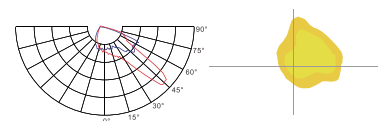

PR

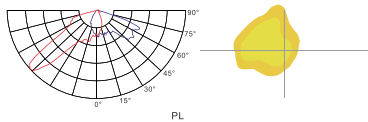

PL

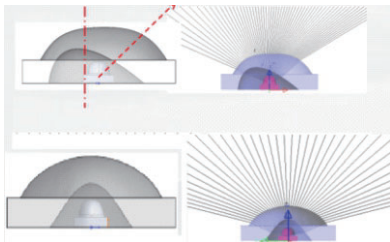

Asymmetric Optics

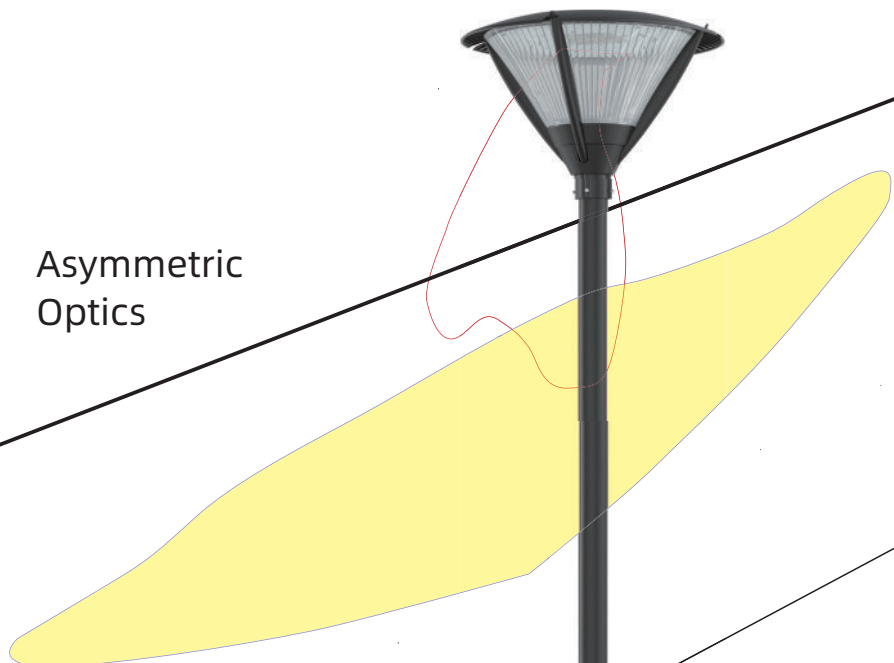

## SUGGESTED INSTALLATION HEIGHT

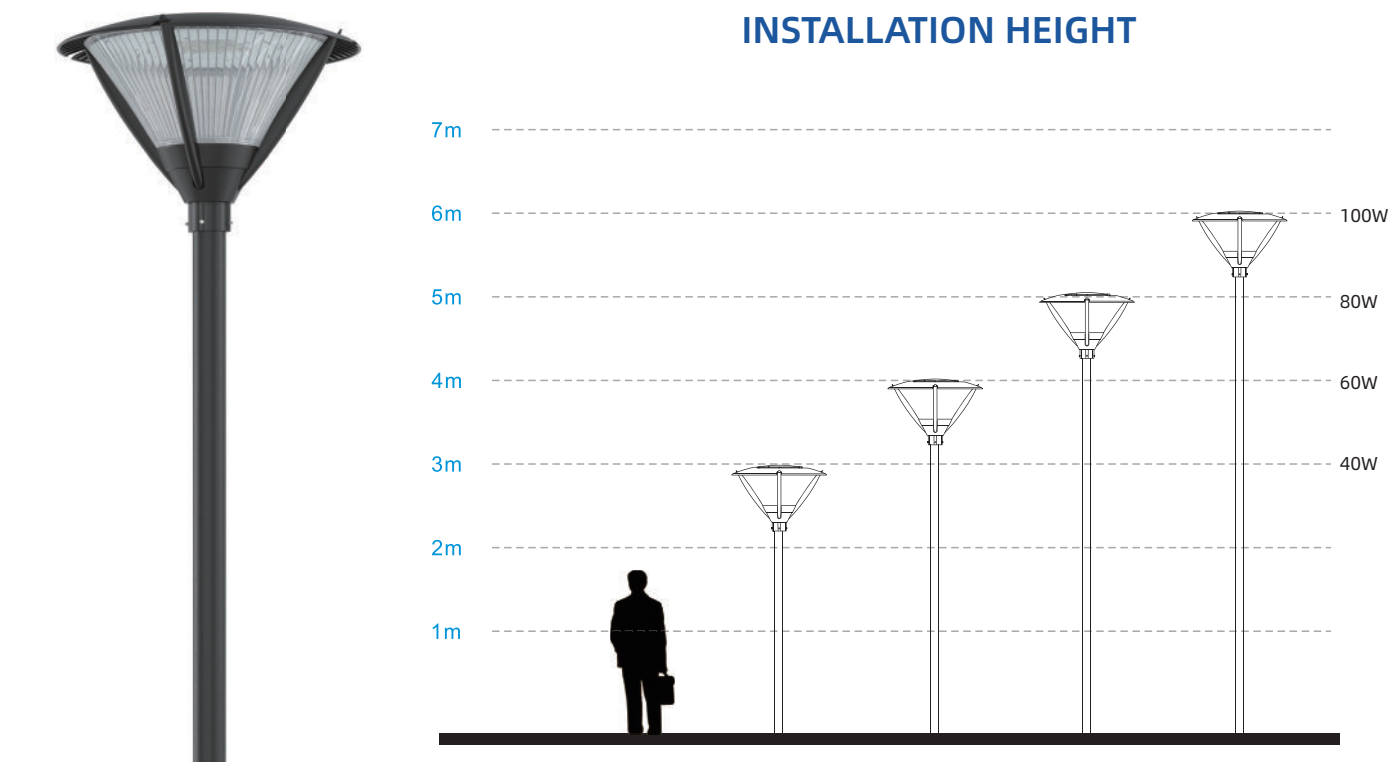

## CHARACTERS

Power	40W	60W	80W	100W
Protection Class	CLASS I/II			
IP/IK Rating	IP66, IK08			
Color Temperature	2200K-6500K	2200K-6500K	2200K-6500K	2200K-6500K
Efficiency	135-150 LM/W	135-150 LM/W	135-150 LM/W	135-150 LM/W
CRI	70/80	70/80	70/80	70/80
Input Voltage	AC 90-305V/347V/480V, 50/60Hz			
Driver Suggest	INVENTRONICS EBS, INVENTRONICS EUM			
Dimming	1-10V Dimming (Default) /Timer Dimming			
Surge Recommendation	10KV (Default) / 20KV (available on request)			
LED Type	LUMILEDS SMD LED			
LED Quantities 3030	64	96	144	160
Pcb Input Current (3030)	48V 725mA	96V 560mA	144V 510mA	120V 760mA
LED Quantities 5050	24	24	36	36
Pcb Input Current (5050)	66V 520mA	66V 820mA	88V 820mA	88V 1050mA
Mounting	On pole with 60 mm top diameter, , adaptor 76 mm top diameter can be chosen			
Material	Die casting with standard adc12 type aluminum, tempered glass, stainless 314 clips and screws. Clear polycarbonate with uv-resistant acrylic. Option for screen for asymmetrical light.			
Painting Color Suggest	RAL9005 Jet Black /Other Colors on request			
Available on request	NEMA socket (3/5/7pins), ZHAGA socket, Short cap, Photocell, NTC, OLC, DALI Dimming			
Weight	Net weight: 8.5kgs   Gross weight: 10.5kgs			
Packing Size	590x590x590mm			